



POWERING INNOVATION THAT DRIVES HUMAN ADVANCEMENT

© 2025 ANSYS, Inc. or its affiliated companies
Unauthorized use, distribution, or duplication is prohibited.

Getting Started with HFSS™: Radar Cross Section



ANSYS, Inc.
Southpointe
2600 Ansys Drive
Canonsburg, PA 15317
ansysinfo@ansys.com
<https://www.ansys.com>
(T) 724-746-3304
(F) 724-514-9494

Release 2025 R1
January 2025

ANSYS, Inc. and ANSYS
Europe, Ltd. are UL registered
ISO 9001:2015 companies.

Copyright and Trademark Information

© 1986-2025 ANSYS, Inc. Unauthorized use, distribution or duplication is prohibited.

ANSYS, Ansys Workbench, AUTODYN, CFX, FLUENT and any and all ANSYS, Inc. brand, product, service and feature names, logos and slogans are registered trademarks or trademarks of ANSYS, Inc. or its subsidiaries located in the United States or other countries. ICM CFD is a trademark used by ANSYS, Inc. under license. All other brand, product, service and feature names or trademarks are the property of their respective owners. FLEXIm and FLEXnet are trademarks of Flexera Software LLC.

Disclaimer Notice

THIS ANSYS SOFTWARE PRODUCT AND PROGRAM DOCUMENTATION INCLUDE TRADE SECRETS AND ARE CONFIDENTIAL AND PROPRIETARY PRODUCTS OF ANSYS, INC., ITS SUBSIDIARIES, OR LICENSORS. The software products and documentation are furnished by ANSYS, Inc., its subsidiaries, or affiliates under a software license agreement that contains provisions concerning non-disclosure, copying, length and nature of use, compliance with exporting laws, warranties, disclaimers, limitations of liability, and remedies, and other provisions. The software products and documentation may be used, disclosed, transferred, or copied only in accordance with the terms and conditions of that software license agreement.

ANSYS, Inc. and ANSYS Europe, Ltd. are UL registered ISO 9001: 2015 companies.

U.S. Government Rights

For U.S. Government users, except as specifically granted by the ANSYS, Inc. software license agreement, the use, duplication, or disclosure by the United States Government is subject to restrictions stated in the ANSYS, Inc. software license agreement and FAR 12.212 (for non-DOD licenses).

Third-Party Software

See the legal information in the product help files for the complete Legal Notice for Ansys proprietary software and third-party software. If you are unable to access the Legal Notice, please contact ANSYS, Inc.

Conventions Used in this Guide

Please take a moment to review how instructions and other useful information are presented in this documentation.

- Procedures are presented as numbered lists. A single bullet indicates that the procedure has only one step.
- Bold type is used for the following:
 - Keyboard entries that should be typed in their entirety exactly as shown. For example, “**copy file1**” means you must type the word **copy**, then type a space, and then type **file1**.
 - On-screen prompts and messages, names of options and text boxes, and menu commands. Menu commands are often separated by greater than signs (>). For example, “click **HFSS > Excitations > Assign > Wave Port.**”
 - Labeled keys on the computer keyboard. For example, “Press **Enter**” means to press the key labeled **Enter**.
- Italic type is used for the following:
 - Emphasis.
 - The titles of publications.
 - Keyboard entries when a name or a variable must be typed in place of the words in italics. For example, “**copy filename**” means you must type the word **copy**, then type a space, and then type the name of the file.
- The plus sign (+) is used between keyboard keys to indicate that you should press the keys at the same time. For example, “Press Shift+F1” means to press the **Shift** key and, while holding it down, press the **F1** key also. You should always depress the modifier key or keys first (for example, Shift, Ctrl, Alt, or Ctrl+Shift), continue to hold it/them down, and then press the last key in the instruction.

Accessing Commands: *Ribbons*, *menu bars*, and *shortcut menus* are three methods that can be used to see what commands are available in the application.

- The *Ribbon* occupies the rectangular area at the top of the application window and contains multiple tabs. Each tab has relevant commands that are organized, grouped, and labeled. An example of a typical user interaction is as follows:

"Click **Draw > Line**"



This instruction means that you should click the **Line** command on the **Draw** ribbon tab. An image of the command icon, or a partial view of the ribbon, is often included with the instruction.

- The *menu bar* (located above the ribbon) is a group of the main commands of an application arranged by category such File, Edit, View, Project, etc. An example of a typical user interaction is as follows:

"On the **File** menu, click the **Open Examples** command" means you can click the **File** menu and then click **Open Examples** to launch the dialog box.

- Another alternative is to use the *shortcut menu* that appears when you click the right-mouse button. An example of a typical user interaction is as follows:

"Right-click and select **Assign Excitation > Wave Port**" means when you click the right-mouse button with an object face selected, you can execute the excitation commands from the shortcut menu (and the corresponding sub-menus).

Getting Help: Ansys Technical Support

For information about Ansys Technical Support, go to the Ansys corporate Support website, <http://www.ansys.com/Support>. You can also contact your Ansys account manager in order to obtain this information.

All Ansys software files are ASCII text and can be sent conveniently by e-mail. When reporting difficulties, it is extremely helpful to include very specific information about what steps were taken or what stages the simulation reached, including software files as applicable. This allows more rapid and effective debugging.

Help Menu

To access help from the Help menu, click **Help** and select from the menu:

- **[product name] Help** - opens the contents of the help. This help includes the help for the product and its *Getting Started Guides*.
- **[product name] Scripting Help** - opens the contents of the *Scripting Guide*.
- **[product name] Getting Started Guides** - opens a topic that contains links to Getting Started Guides in the help system.

Context-Sensitive Help

To access help from the user interface, press **F1**. The help specific to the active product (design type) opens.

You can press **F1** while the cursor is pointing at a menu command or while a particular dialog box or dialog box tab is open. In this case, the help page associated with the command or open dialog box is displayed automatically.

Table of Contents

Table of Contents	Contents-1
1 - Introduction	1-1
RCS Model	1-1
General Procedure	1-2
2 - Create the RCS Model	2-1
Create a New Project and Insert an HFSS Design	2-1
Add Project Notes	2-3
Enable Legacy View Orientations	2-3
Choose Solution Type	2-5
Set Up the Drawing Region	2-6
Set Model Length Unit	2-6
Coordinate System Settings	2-7
Grid Settings	2-7
Ruler Visibility	2-7
Create the Target Box	2-8
Create the Open Region	2-10
Define Mesh Size at Open Region Faces	2-13
Add the Incident Plane Wave	2-14
3 - Set Up and Run the Analysis	3-1
Add a Solution Setup	3-1
Validate the Design	3-2
Analyze the Design	3-2
View the Solution Data	3-3
4 - RCS Post Processing	4-1
Far Field Infinite Sphere Setup Overview:	4-1
Create Bistatic RCS Setup	4-3
Create Monostatic RCS Plot	4-5
Create Bistatic RCS Plot	4-7

5 - Optionally, Restore Current View Orientations Contents-1

1 - Introduction

This *Getting Started* guide describes how to model a Radar Cross Section (RCS). This guide shows how to create and solve a model for computing RCS.

In this tutorial the following tasks are performed using HFSS:

- Draw the model geometry
- Create an open region with Perfectly Matched Layer (PML) boundaries
- Add the excitation
- Setup mesh operations
- Specify solution settings
- Validate the design setup
- Run HFSS simulations
- Create 2D X-Y plots.

RCS Model

The model for this simulation consists of a perfect electrical conductor (pec) target cube surrounded by an open region. The open region faces have PML (perfectly matched layer) boundaries. You will draw the target object and automatically create an open region with PML boundaries. The excitation is an incident plane wave.

The model has been kept fairly simple, to keep the solution time short. The purpose is to illustrate the basic principles in setting up this kind of problem and to demonstrate post processing for the RCS information.

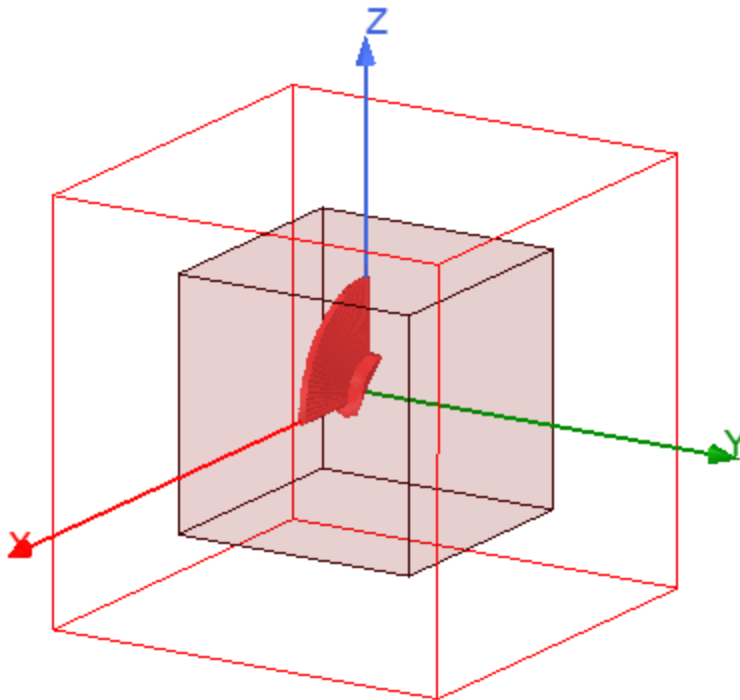

The radar cross-section (RCS) or echo area, σ , is measured in meters squared and represented for a bistatic arrangement (that is, when the transmitter and receiver are in different locations as shown in the figure below).

The following diagram shows the bistatic RCS concept, with separate transmitting and receiving antennas:

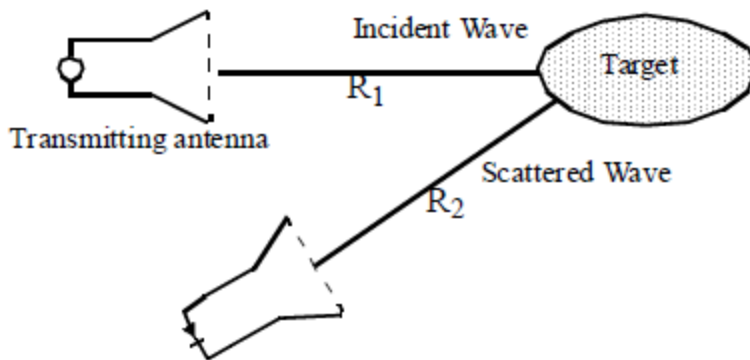

HFSS supports RCS for Bistatic, Normalized Bistatic, Complex Bistatic, and Monostatic conditions. In this tutorial, you will generate plots for Normalized Bistatic and Monostatic situations.

General Procedure

The general procedure for creating and analyzing this RCS project is summarized as follows:

1. Create a project for HFSS:
 - a. Open a new project in Ansys Electronics Desktop
 - b. Add an HFSS design to the new project
2. Draw the model geometry (in this case, a radar target) and a create a surrounding open region:
 - a. Set the model length unit
 - b. Create the radar target box and assign its material (*pec*)
 - c. Create an open region with PML boundaries
3. Assign the incident plane wave excitation
4. Generate a solution:
 - a. Set up the solution criteria
 - b. Define mesh operations to refine the mesh
 - c. Generate the solution
5. Evaluate the results of the RCS solution:
 - a. Define bistatic RCS far field radiation sphere setup
 - b. Create bistatic RCS plot
 - c. Define monostatic RCS far field radiation sphere setup
 - d. Create monostatic RCS plot



2 - Create the RCS Model

This section shows how to create the simple RCS model. The major steps are as follows.

- Create a New Project and Insert an HFSS Design
- Add Project Notes
- Enable Legacy View Orientations
- Choose Solution Type
- Set Up the Drawing Region:
 - Set Model Length Unit
 - Coordinate System Settings
 - Grid Settings
 - Ruler Visibility
- Draw the Target Box
- Create Open Region with PML Boundaries
- Define Mesh Size at Open Region Faces
- Add the Incident Plane Wave

Create a New Project and Insert an HFSS Design

The first step in using HFSS to solve a problem is to create a project in which to save all the data associated with the problem. When you launch the Ansys Electronics Desktop application, a default new project (named Projectx) is created automatically. Otherwise, if the application was already open, and you closed the project that had been open, you can manually create a new project. In either case, you will insert an HFSS design type into the new project.

1. Launch the Ansys Electronics Desktop application if it is not already running.
2. If an empty project is not already listed at the top of the Project Manager, click  **New** on the **Desktop** ribbon tab.
3. On the **Desktop** ribbon tab, click  **HFSS** (Insert HFSS design). You do not have to access the HFSS drop-down menu since the default action is to insert a regular HFSS design type.

The *Modeler* window appears on the desktop, the ribbon advances to the *Draw* tab, and **HFSSDesignx (Terminal Network)** appears under Projectx in the Project Manager:

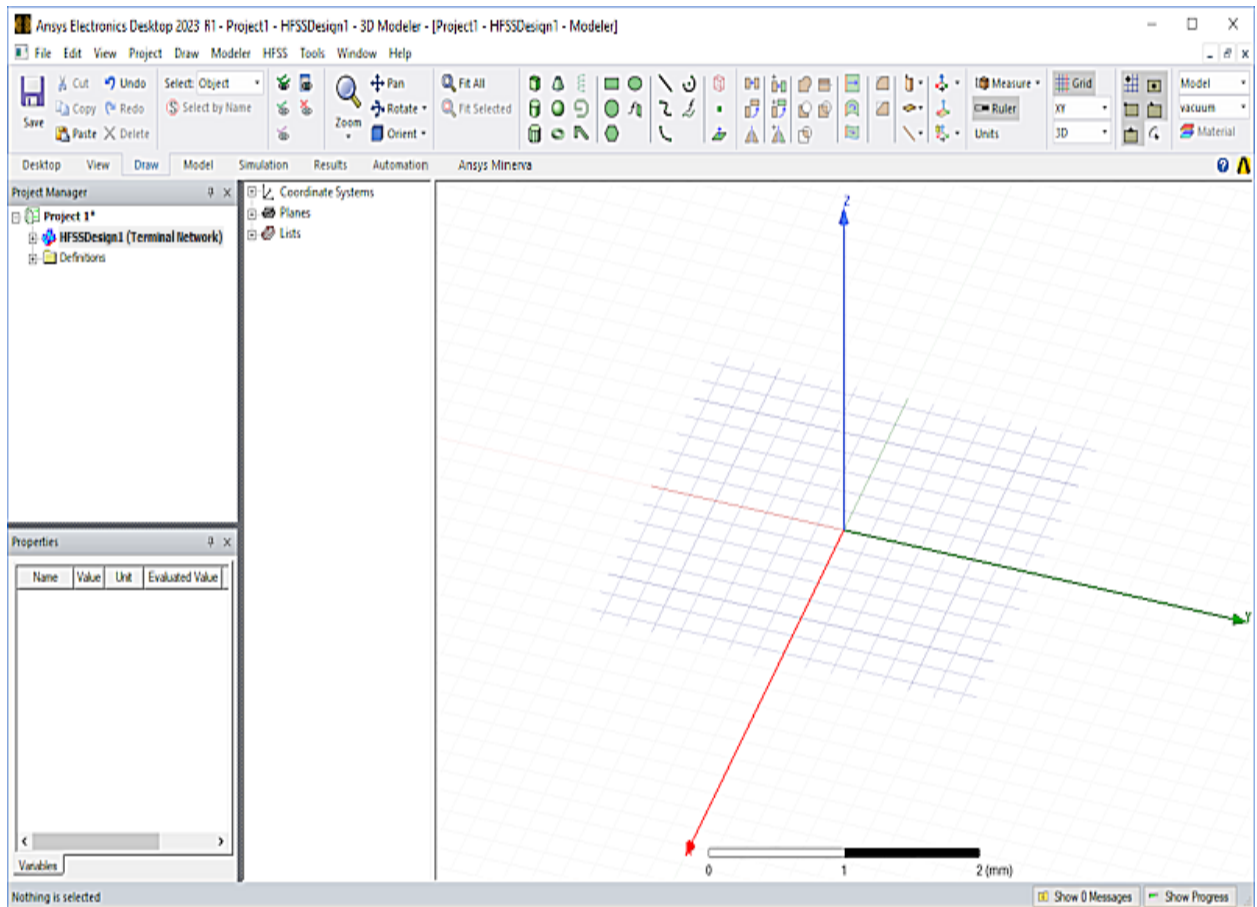

4. In the Project Manager, right-click **Projectx** and choose **Rename** from the shortcut menu. Then, type **RCS_Example** as the new name and press **Enter**.



The project is both renamed and saved, so this step is equivalent to using the *Save As* command on the *Desktop* ribbon tab or *File* menu. An asterisk (*) appears to the right of the project name and design type to indicate when there are unsaved changes. The missing asterisk tells you that the renamed project is already saved.

5. Click the plus sign (+) to expand the **HFSSDesignx (Terminal Network)** branch.

Add Project Notes

Optionally, you can enter notes about your project, such as its creation date and a description of the device being modeled. These notes are useful for keeping a running log of the project.

To add notes to the project:

6. Using the menu bar, click **HFSS > Edit Notes**.

The *Design Notes* dialog box appears.

7. Click in the *Design Notes* text box and type your notes. For example, you could type the title of the tutorial: **Getting Started with HFSS: Radar Cross Section**. You could also add the software version and date:

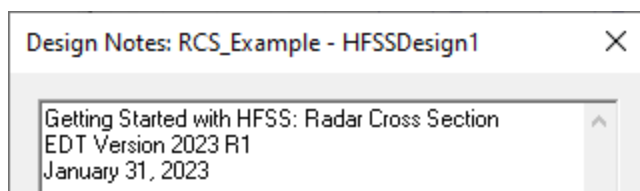

8. Click **OK** to save the notes with the current project.

Note:

To display or edit existing project notes, double-click **Notes** in the Project Manager.

For information on any HFSS topic (such as coordinate systems, grid settings, commands, or windows), you can view the context-sensitive help:

- Press **F1** to open the HFSS Help in your web browser. If you have a dialog box open, the Help opens to a page that describes that dialog box.
- Use the commands from the **Help** menu.

Enable Legacy View Orientations

This getting started guide was created based on standard view orientations that were in effect for version 2023 R2 and earlier of the Ansys Electronics Desktop application. For consistency between your experience and the views and instructions contained in this guide, select the *Enable Legacy View Orientation* option in the 3D UI Options dialog box, as follows:

1. From the menu bar, click **View > Options**.

The *3D UI Options* dialog box appears.

2. Select **Enable Legacy View Orientation**:

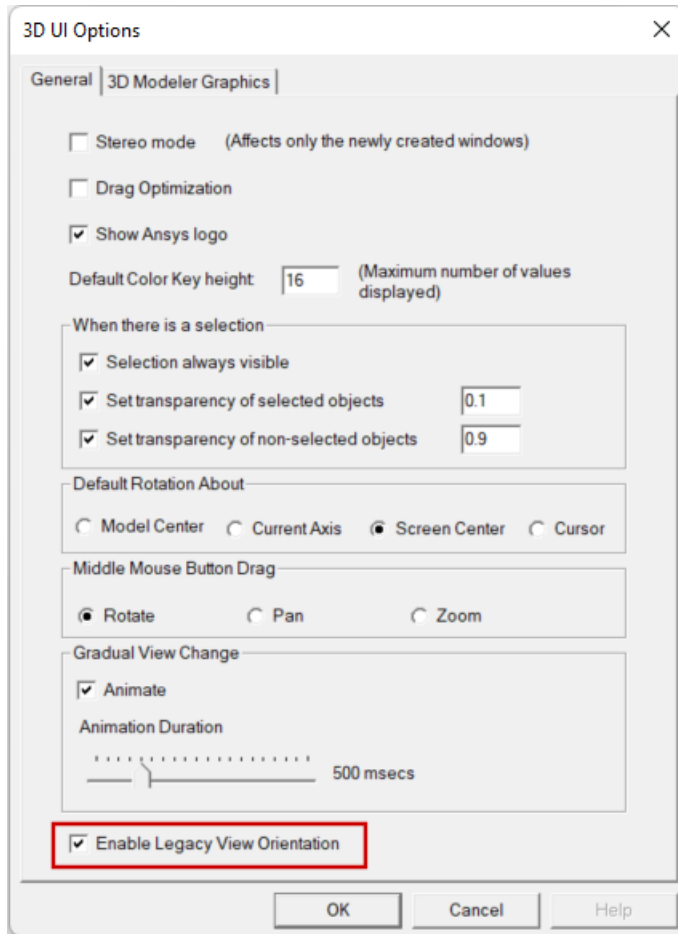

3. Click **OK**.

Changing the view orientation option does not change the model viewpoint that was in effect at the time.

4. On the **Draw** ribbon tab, click  **Orient** to change to the *Trimetric* view, which is the default legacy view orientation.

You do not have to select *Trimetric* from the *Orient* drop-down menu. The default view appears when you click *Orient*.

Although this option can only be accessed once a design is added to a project, it is a global option. Your choice is retained for all future program sessions, projects, and design types that use the 3D Modeler or that produce 3D plots of results.

At the end of this guide, you will be prompted to clear the *Enable Legacy View Orientation* option, if you prefer to use the view orientation scheme implemented for 2024 R1 and newer versions going forward.

For a comparison of the legacy and current view orientations, search for "*View Options: 3D UI Options*" in the HFSS help. Additionally, views associated with **Alt + double-click** zones have

been redefined. The current orientations are shown in the help topic, "*Changing the Model View with Alt+Double-Click Areas.*"

Choose Solution Type

If your HFSS analysis will differ from the default *Terminal Network* option, or if you have saved different solution type options as the default, you must specify the solution type before building the model. As you set up your model, available options will depend on the design's solution type settings. We will look at the *Solution Type* dialog box, choose the *Modal* option, and briefly review the available options.

To specify the solution type:

1. Using the menu bar, click **HFSS > Solution Type** or right-click **HFSSDesignx** in the Project Manager and choose **Solution Type** from the shortcut menu.

The *Solution Type* dialog box appears.

2. Under *Options*, select **Modal**.

This RCS project is a mode-based problem in which incident plane wave scattering must be computed.

3. Additionally, ensure that the following other settings are specified:

- Under *Solution Types*:
 - **HFSS** is selected
- Under *Options*:
 - **Network Analysis** is selected
 - *Auto-Open Region* is cleared (**not** selected)

Some of the available solution types and options are described below:

- **Modal:** This option is applicable to *HFSS* and *HFSS with Hybrid and Arrays* solutions. It calculates mode-based S-parameters of passive, high frequency structures such as microstrips, waveguides, and transmission lines, which are "driven" by a source, and it computes incident plane wave scattering.
- **Terminal:** This option is applicable to *HFSS* and *HFSS with Hybrid and Arrays* solutions. It calculates the terminal-based S-parameters of passive, high frequency structures with multi-conductor transmission line ports, which are "driven" by a source.
- **Eigenmode:** This solution type calculates Eigenmodes or resonances of a structure. The Eigenmode solver finds the resonant frequencies of the structure and the fields at those resonant frequencies.
- **Transient:** This solution type solves problems in a time domain using the time-domain solver. You can specify the *Driven Options* as *Composite Excitation* or *Network Analysis* for the setup.

- Click **OK** to accept the *Modal* option for this design.

The design is now listed in the Project Manager as **HFSSDesignx (Modal Network)**.

Set Up the Drawing Region

The next step is to set up the drawing region to suit the modeling requirements and your personal preferences. The drawing region setup includes setting the default length unit, choosing a coordinate system, setting the coordinate system display options, choosing preferred grid settings, and showing or hiding the *Ruler* that appears at the bottom of the Modeler windows drawing area.

Set Model Length Unit

Now, specify the drawing units for your model. For this RCS problem, set the drawing unit to meters, as follows:

- On the Draw ribbon tab, click **Units**.

The *Set Model Units and Max Extent* dialog box appears.

- Select **meter** from the **Select units** drop-down menu.

Make sure the **Rescale to new units** and **Advanced** options are cleared (*not* selected).

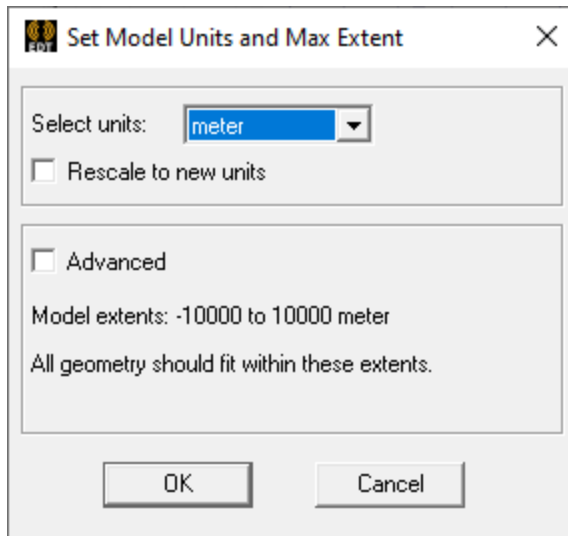

If selected, the **Rescale to new units** option maintains the current numerical dimensions but reassigns the unit, effectively changing the size of all existing objects. For example when changing from inches to millimeters with this option selected, a 1 inch edge becomes 1mm long (1/25.4 times its original length). Use this option only if existing geometry was accidentally drawn using the correct numerical value but the wrong length unit setting. When *Rescale to new units* is not selected, existing objects remain the same size,

but their numerical value is adjusted based on the conversion factor between the old and new length unit.

3. Click **OK** to accept meters as the units for this model.

Coordinate System Settings

For this RCS problem, use the fixed, default global coordinate system (CS) as the working CS. The working CS is the currently active one on which new objects that you draw will be based.

HFSS has three types of coordinate systems that let you easily orient new objects: the *Global* coordinate system, *relative* coordinate systems, and *face* coordinate systems. Every CS has an X-axis and Y-axis that are at a right angle to each other and a Z-axis that is perpendicular to the XY plane. The origin (0,0,0) of every CS is located at the intersection of the X-, Y-, and Z-axes.

In addition to choosing the global coordinate system or creating a user-defined one, you can change the way the coordinate system is displayed. To do so, use the menu bar to click an available option under **View > Coordinate System**. The images in this guide are based on the **Large** option.

Grid Settings

From the menu bar, click **View > Grid Settings**. In the resulting *Grid Spacing* dialog box, you can specify the grid type (Cartesian or Polar), style (Dot or Line), extents (full window or automatically reduced), auto-adjust density or spacing, and visibility. If you prefer to have fixed grid line increments, disable the **Auto adjust density to: xx pixels** option and specify the desired **dX**, **dY**, and **dZ** values (or **dR** and **dTheta** for *Polar* grids). When the auto adjust density option is selected, the grid spacing does not vary continuously as you zoom in or out. Rather, it adjusts in predefined multiples or divisions of the active length unit (such as 10 mm, 5 mm, 2 mm, 1 mm, 0.5 mm, 0.2 mm, 0.1 mm ... as you zoom in).

The following **Grid visibility** options are available:

- **Show:** Grid is always visible.
- **Hide:** Grid is never visible (though the cursor still snaps to grid points while drawing).
- **Auto:** Grid is visible when a drawing operation is being performed but hidden otherwise.

The images in this guide are based on an always visible grid, Cartesian grid type, Line style, automatic extents, and automatic density based on 30 pixels. These settings are the defaults for a clean installation of the software.

Ruler Visibility

On the **Draw** ribbon tab, click  **Ruler** to toggle the visibility of the ruler that appears at the bottom of the Modeler window's drawing area. Most of the images in this guide are captured with the ruler hidden.

Create the Target Box

The target box is a perfect electrical conductor (pec) that is 0.75 meter regular cube (0.4219 m³ volume). To create the target box:

1. From the **Draw** ribbon tab, click  **Draw box**.
2. Press **F4** to ensure that you are in the dialog box data entry mode.

The *CreateBox* dialog box should be visible.

3. In the **Command** tab of the *CreateBox* dialog box, edit the properties as shown in the following image:

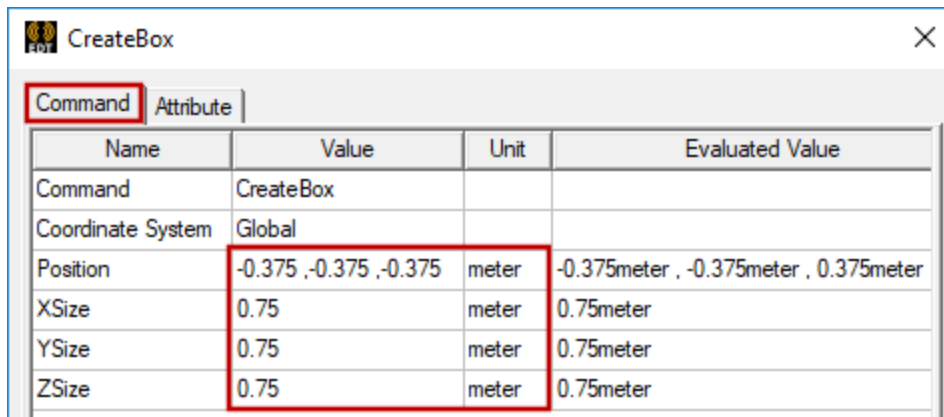

4. In the **Attribute** tab of the *CreateBox* dialog box, make the following changes:
 - a. Change the **Name** to **Target**.
 - b. From the **Material** drop-down menu, choose **Edit** to access the *Select Definition* dialog box. Then:
 - i. Type **pec** in the **Search by Name** field.
The *pec* material is located and selected in the list of library materials.
 - ii. Click **OK** to accept the selected material.
 - c. Ensure that the **Material Appearance** option is **not** selected.
 - d. Click the **Color Value**, change the object color to **dark red** (column 1, row 4 of the color samples; Red: 128, Green: 0, Blue:0), and click **OK** to close the *Color* dialog box.
 - e. Change the **Transparent** value to **0.6**.

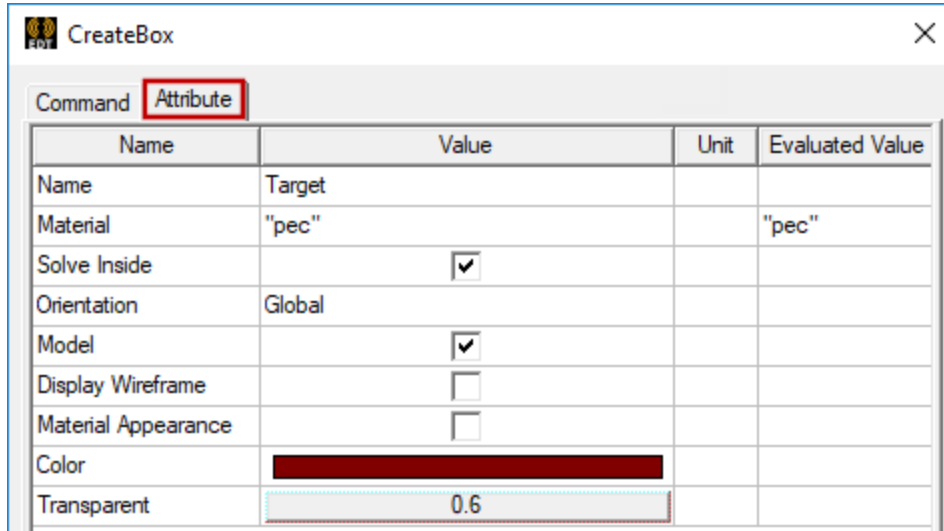

- Click **OK** to close the *CreateBox* dialog box.

Note:

The *pec* material is a perfect electrical conductor. When this type of material is selected, the object's **Solve Inside** option is automatically cleared as soon as you click *OK* to close the drawing tool's dialog box. For the box just created, the *Attribute* tab of the docked *Properties* window should now match the following image:

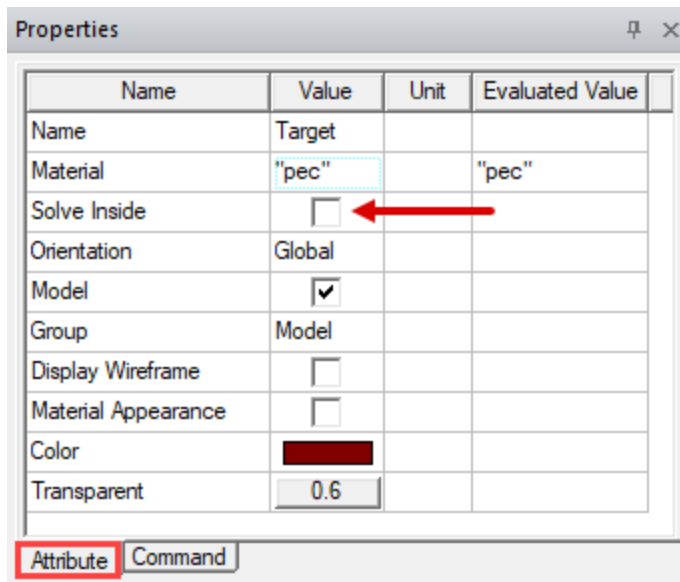

- If necessary, press **Ctrl+D** to fit the cube to the display area.
- Click in the Modeler window's background area to clear the selection.

The centroid of the resulting cube should be at the global origin, and your model should look like the following image:

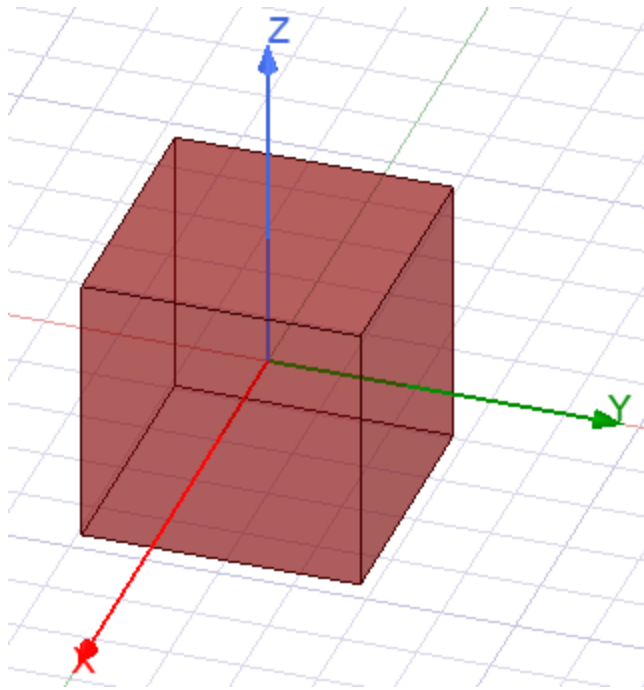

Create the Open Region

An open region is a volume (generally assumed to be a vacuum) encompassing a model. The padding (that is, the distance between the model and the open region boundaries) is determined automatically based on the specified solution frequency. Fields surrounding the model are calculated within the open region.

It is no longer necessary for you to manually draw a vacuum or air box around a model and assign the appropriate boundaries. (However, you may choose to manually create such a box to customize its size for certain modeling scenarios.) There are two ways to automate the open region creation process:

- Use the menu bar command, **HFSS > Model > Create Open Region**:

Creates an open region object, assigns the requested boundary type, and creates default radiation setups. This command also provides the option of defining an infinite ground plane at the extreme face of the model in any of the six global directions. When an infinite ground plane is defined, the open region is terminated at the specified end of the model rather than extending beyond it.

- Select the **Auto-open region** option in the *Solution Type* dialog box:

Creates an invisible open region (not a physical object in the History Tree), assigns the requested boundary type, creates default radiation setups, and also creates an automatic

analysis setup. This option does not provide the option of defining an infinite ground plane. Therefore, it always includes padding on all sides of the model.

Either of these methods automatically produces an open region of a suitable size for radiation processing. Additionally, the requested boundary type is assigned to all open region faces. The first option creates open region objects in the History Tree. The second option handles the open region during the analysis process but does not create or list model objects that you can see.

In this exercise, you will specify the PML (perfectly matched layer) boundary type. When this type of boundary is specified, several groups of PML radiating surfaces are also created and listed in the History Tree. The padding (that is, the distance from the model's faces to the open region's boundaries) for the PML boundary option is set as one-fourth of the signal wave length ($\lambda/4$).

Note:

For additional information, search the HFSS help for *Create Open Region*.

To create the open region:

1. Using the menu bar, click **HFSS > Model > Create Open Region**.
2. In the *Create Open Region* dialog box that appears, specify the settings shown in the following image:

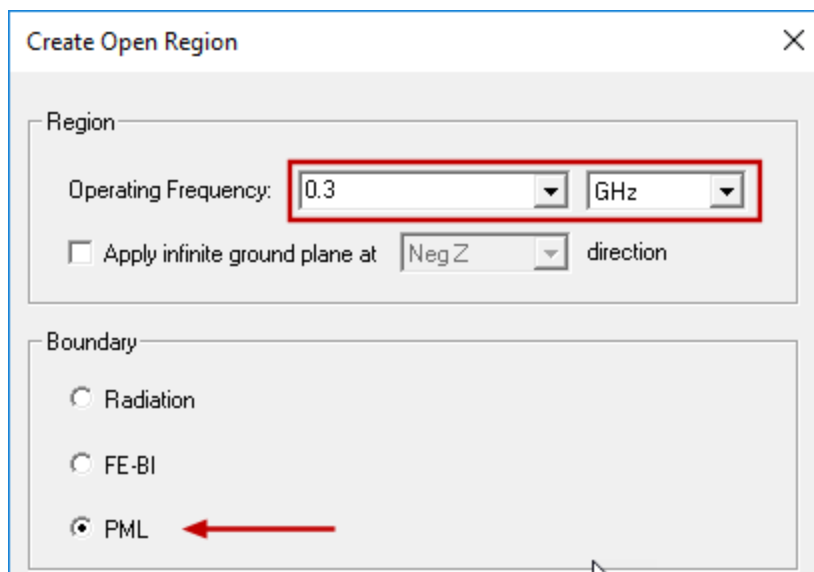

3. Click **OK**.

Four PML groups and one vacuum object are added to the History Tree:

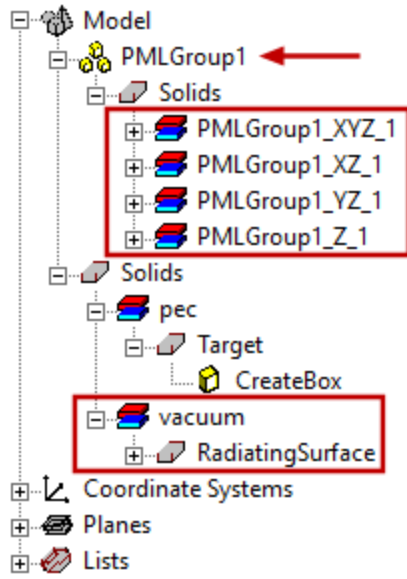

The PML radiation boundaries are listed in the Project Manager:

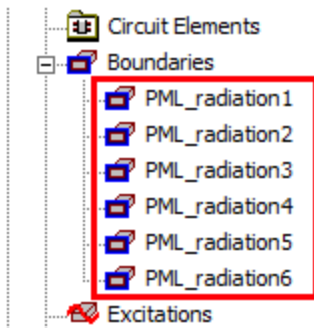

4. Press **Ctrl+D** to fit the view.

The open region is displayed as a red wireframe:

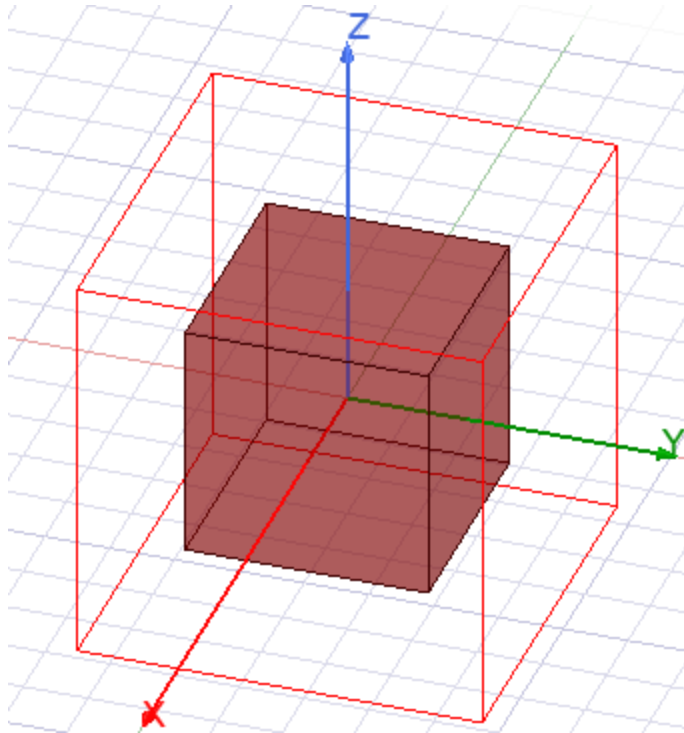

5. Under *Model* > *Solids* > *vacuum* in the History Tree, select **RadiatingSurface**.

The object attributes are displayed in the docked *Properties* window.

6. In the **Attribute** tab of the docked *Properties* window, change the **Name** to **OpenRegion** and press **Enter**.
7. Under *Model* > *Solids* > *vacuum* > *OpenRegion* in the History Tree, select **CreateRegion**.

In the docked *Properties* window, notice that the X, Y, and Z Padding values for the region are all 0.25 meter. The wavelength (λ) at 300 MHz (0.3 GHz) is 1 meter.

$\lambda = c/f = 300,000,000 \text{ m/sec} / 300,000,000 \text{ cycles/sec} = 1 \text{ meter}$. Therefore, the padding is $\lambda/4$, as expected.

8. Clear the current selection.

9.  **Save** your project.

Define Mesh Size at Open Region Faces

Define a mesh size of $\lambda/5$ (0.2 meter) at the open region faces. This element size will result in an accurate radiation pattern.

1. Under *Model* > *Solids* > *vacuum* in the History Tree, right-click **OpenRegion** and choose **Select > All Faces** from the shortcut menu.

- Right-click on **Mesh** in the Project Manager and choose **Assign Mesh Operation > On Selection > Length Based**.

The *Element Length Based Refinement* dialog box appears.

- Set the **Maximum element length** value to **0.2 meter**:

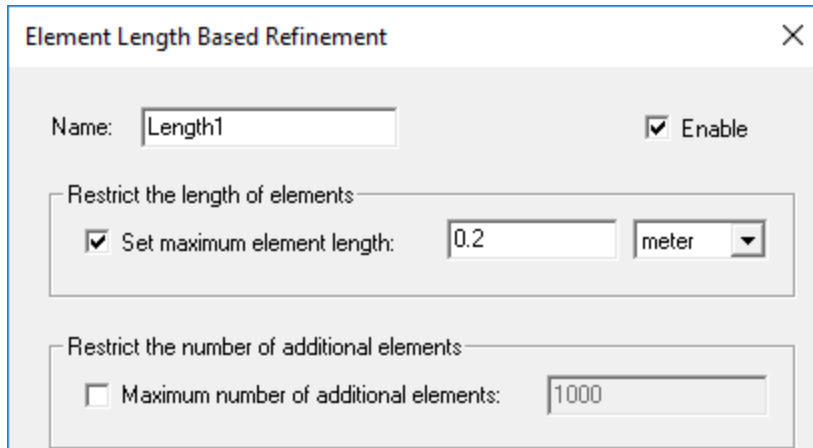

- Click **OK**.

Length1 appears under *Mesh* in the Project Manager.

Note:

Even if an object is selected (instead of its faces), this mesh operation is applied only at the boundary faces of the object. Alternatively, to enforce the maximum element length restriction throughout an object's volume, select the object, right-click **Mesh** in the Project Manager, and choose *Assign Mesh Operation > Inside Selection > Length Based*.

Add the Incident Plane Wave

An incident plane wave is a wave that propagates in one direction and is uniform in the directions perpendicular to its direction of propagation.

- From the menu bar, click **HFSS > Excitations > Assign > Incident Wave > Plane Wave** or right-click **Excitations** in the Project Manager and choose **Assign > Incident Wave > Plane Wave** from the shortcut menu.

The *General Data* step of the *Incident Wave Source* wizard appears.

- Specify the following settings:

- a. Select the **Spherical** option for the **Vector Input Format**.
- b. **X Coord**, **Y Coord**, and **Z Coord** all equal **0**.

Note:

This location is the origin of the incident wave and/or the zero phase position.

Incident Wave Source : General Data

Name:

Vector Input Format

Cartesian Spherical

Excitation Location and/or Zero Phase Position

X Coord:

Y Coord:

Z Coord:

3. Click **Next**.
4. The *Incident Wave Source* wizard advances to the *Spherical Vector Setup* step.
5. Specify the following settings in the **IWaveTheta** section:
 - a. **Stop = 90 deg** . All other angle settings remain at the **0 deg** default.
 - b. **Step = 3 deg**.

For the monostatic case, the RCS will be computed only at the values of IWaveTheta specified here. For the purposes of this exercise, this setup keeps the number of points down and reduces the solution time.

Incident Wave Source : Spherical Vector Setup

IWavePhi

Start 0 deg Step 0 deg

Stop 0 deg View Point List...

IWaveTheta

Start 0 deg Step 3 deg

Stop 90 deg View Point List...

Eo Vector

Phi 1 V / m

Theta 0 V / m

Note that the Eo vector will be normalized to a unit vector. Use the Edit Sources dialog to scale that vector as needed.

- c. Click **View Point List** to see the values of Theta:

Theta Values

0.000 deg
3.000 deg
6.000 deg
9.000 deg
12.000 deg
15.000 deg
18.000 deg
21.000 deg
24.000 deg
27.000 deg
30.000 deg
33.000 deg
36.000 deg
39.000 deg
42.000 deg
45.000 deg
48.000 deg
51.000 deg
54.000 deg
57.000 deg

- d. Click **Done** to close the *Theta Values* list.
6. Click **Next**.

The *Incident Wave Source* wizard advances to the *Plane Wave Options* step.

7. Ensure that the **Regular/Propagating** option is selected under **Type of Plane Wave**.

No other settings are active when this option is selected.

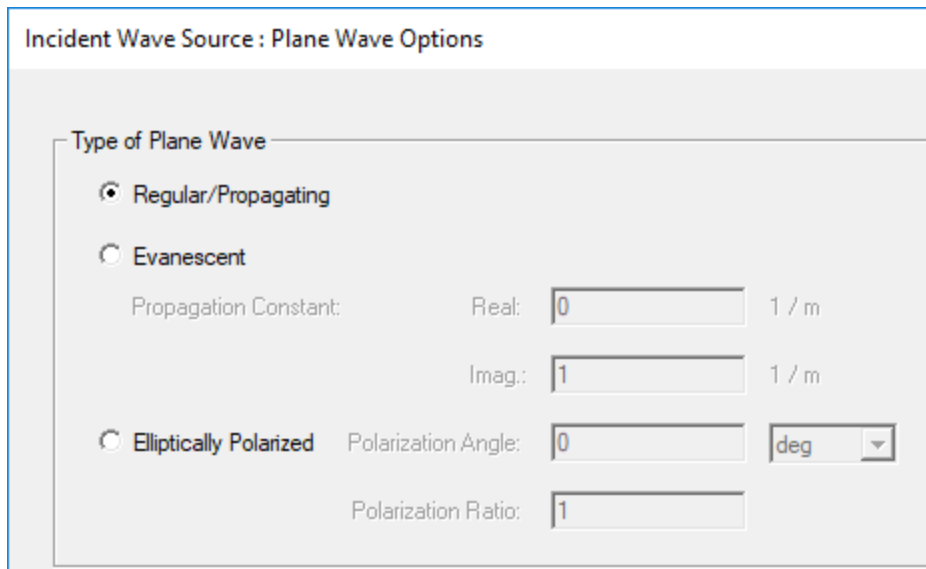

8. Click **Finish**.

The incident wave you defined is added under *Excitations* in the Project Manager and displayed on the model when selected:

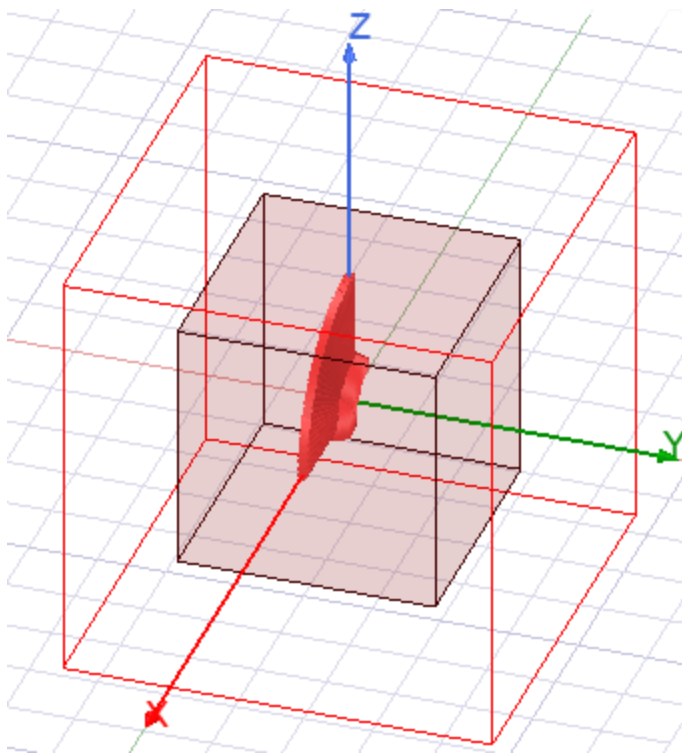

9. Clear the selection.

3 - Set Up and Run the Analysis

Next, you will complete the following tasks:

- Add a Solution Setup
- Validate the Design
- Analyze the Design
- View the Solution Data

Add a Solution Setup

Specify how HFSS will compute the solution by adding a *solution setup* to the design. You will instruct HFSS to perform an adaptive analysis at 0.3 GHz. During an adaptive analysis, HFSS refines the mesh iteratively in the areas of highest error.

1. On the **Simulation** ribbon tab, click  **Setup > Advanced**.

The *Driven Solution Setup* dialog box appears.

2. Under the **General** tab, specify **0.3 GHz** as the **Frequency**.

Keep the default values and options for all other settings.

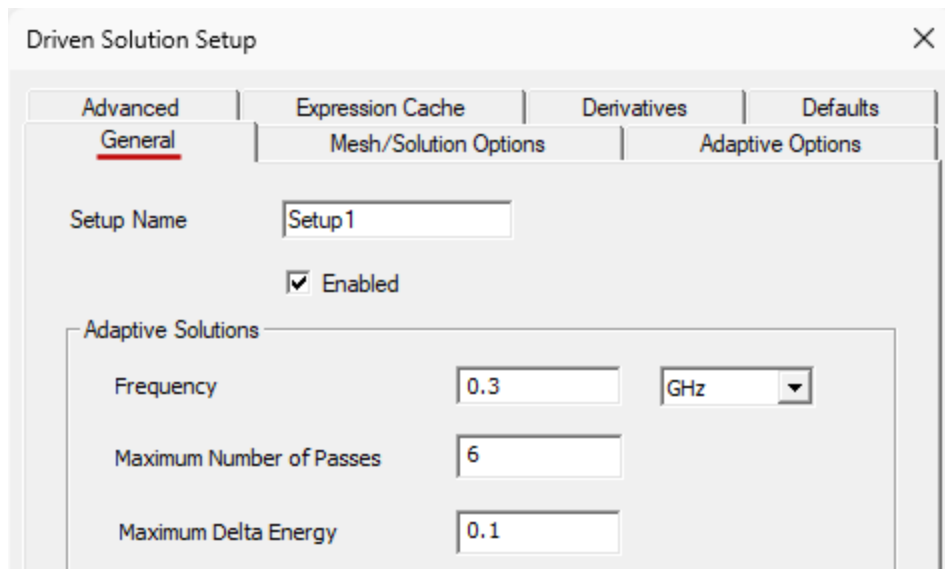

Note:

The *Maximum Number of Passes* is the maximum number of mesh refinement cycles that HFSS will perform in attempting to achieve a converged solution. The solution is considered to be converged when the change in energy between consecutive iterations is equal to or less than the specified *Maximum Delta Energy* value.

3. Click **OK**.

The solution setup (named *Setup1* by default) is listed under *Analysis* in the Project Manager

Validate the Design

Before you run an analysis, it is helpful to verify that all of the necessary setup steps have been completed and their parameters are reasonable.

4. On the **Simulation** ribbon tab, click  **Validate**.

The *Validation Check* window appears, and there should be no errors or warnings:

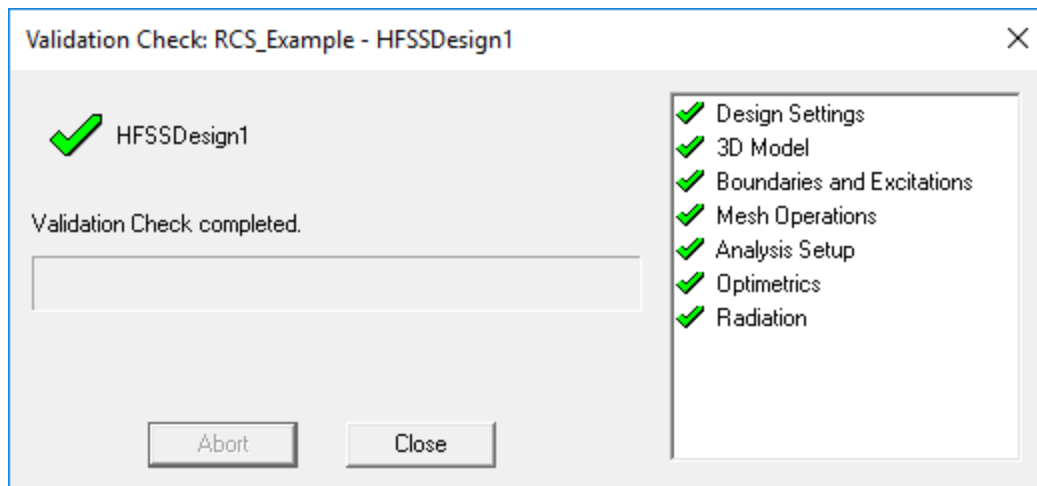

5. Click **Close**.

Analyze the Design

Now you will run the simulation.

6. On the **Simulation** ribbon tab, click  **Analyze All**.

HFSS computes the 3D field solution for every solution setup in the project. In this problem, *Setup1* is the only setup.

The solution process is expected to take a minute or less to run on a fairly current computer workstation. When the solution is complete, a confirmation message appears in the *Message Manager* window.

The *Progress* window displays the solution progress as it occurs.

View the Solution Data

While the analysis is running, or after it is finished, you can view a variety of solution profile, convergence, and matrix data.

7. On the **Results** ribbon tab, click **Solution Data**.

The *Solutions* dialog box appears.

8. Select one or more of the following three tabs to view the solution data of interest:
- **Profile:** This tab contains a log of the solution process and includes items such as adaptive meshing passes, matrix assembly, solver, field recovery, and more. The *Real Time*, *CPU Time*, and *Memory* usage is reported for each process along with the total elapsed time and memory usage.
 - **Convergence:** This tab shows the *Pass Number*, the number of *Solved Elements*, and the *Max Delta Energy* (the convergence criterion) for each adaptive pass of the solution. You can display the convergence data as a table or plot. However, the plot is only meaningful if more than two passes have been completed. In the case of this RCS example, the solution converges in only two passes.
 - **Mesh Statistics:** This tab list the mesh data separately for all objects in the model (in this case, the *Target*, *OpenRegion*, and all of the *PML* objects on the outside of the open region. The number of tets, min and max edge lengths, min and max volumes, and more statistics are tabulated.

Note:

- The *Matrix Data* tab lists S, Y, and Z matrix coefficients in various formats, but this information is not applicable to the RCS example.
- Alternatively, you can directly access the individual tabs of the *Solutions* dialog box by right-clicking the analysis setup in the Project Manager (in this case, *Setup1*) and selecting **Profile**, **Convergence**, **Matrix Data**, or **Mesh Statistics** from the shortcut menu.

9. Click **Close**.

4 - RCS Post Processing

In the current version of the Ansys Electronics Desktop application, it is no longer necessary to create a monostatic far field radiation sphere setup in order to create a monostatic RCS results report. However, you do need to create the bistatic infinite sphere setup. This chapter shows you how to do so. It then shows you how to create results plots for the monostatic and bistatic configurations (specifically, Normalized Monostatic RCS and Normalized Bistatic RCS plots). Normalized RCS means that the RCS is normalized with respect to the wavelength squared.

The *Create Open Region* command automatically defined three default infinite sphere setups, which are listed under *Radiation* in the Project Manager. None of these three setups are suitable for this RCS example. You will delete two of the three setups and edit the remaining one to produce the desired far field setup for bistatic RCS post processing.

The following topics are included:

- Far Field Infinite Sphere Setup Overview
- Create Bistatic RCS Setup
- Create Monostatic RCS Plot
- Create Bistatic RCS Plot

Far Field Infinite Sphere Setup Overview:

To evaluate radiated fields in the far-field region, you must set up an infinite sphere that surrounds the radiating object. For this example, we will create setups for the bistatic and monostatic cases.

The relationship between phi and theta and the coordinate system axes is shown below:

The sphere can be defined according to any defined coordinate system and before or after a solution has been generated.

When you set up a spherical surface over which to analyze near or far fields, you specify a range and step size for the angles phi and theta. These values indicate the spherical direction in which you want to evaluate the radiated fields. For every value of phi there is a corresponding range of values for theta, and vice versa. This creates a spherical grid. Each grid point indicates a unique direction along a line that extends from the center of the sphere through the grid point. The radiated field is evaluated in this direction. The number of grid points is determined by the ranges and step sizes for phi and theta.

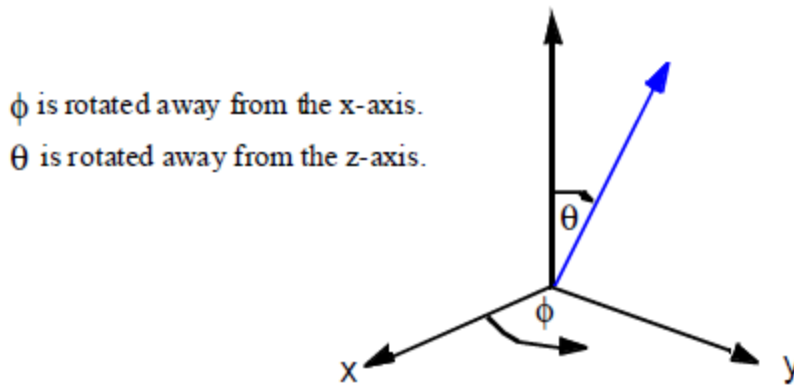

When HFSS evaluates the radiated fields, it needs at least two directions along which to plot the fields. Therefore, if the step size for phi is zero, then the step size for theta must be greater than zero, and vice versa, which ensures that the fields are plotted in at least two directions.

For a far field radiation sphere setup, you must define three angle parameters each for Phi and Theta. You can define these angular parameters in radians, degrees, degree minutes (degmin), or degree seconds (degsec). These three parameters are described as follows:

Start	For Phi and Theta, this parameter is the relative angle of rotation from the X and Y axes, respectively, where the range of Phi and Theta direction vectors begins.
Stop	For Phi and Theta, this parameter is the relative angle of rotation from the X and Y axes, respectively, where the range of Phi and Theta direction vectors ends. The <i>Stop</i> angle must be greater than or equal to the <i>Start</i> angle and less than 360 deg (or 2π radians). If the <i>Stop</i> angle is equal to the <i>Start</i> angle, then HFSS assumes that only one angle should be used, and the <i>Step Size</i> is ignored.
Step Size	The angular increment between the <i>Stop</i> and <i>Start</i> angle, which determines the number vector directions in the Phi or Theta sweep. If the <i>Step Size</i> angle is zero, HFSS assumes that only one angle should be used. Specifically, entering zero for the <i>Step Size</i> causes the sweep to consist of one only the <i>Start</i> angle.

Note:

You must define at least one radiation or PML boundary in the design for HFSS to compute far-field quantities, regardless of which radiation surfaces you instruct HFSS to use when calculating the far fields. You do not have to re-solve the problem if you modify radiation surfaces in the *Far Field Radiation Sphere Setup* dialog box. Far-field results are a post processing function, and their setups do not affect the analysis solution.

Create Bistatic RCS Setup

You will begin by deleting two of the three predefined far field radiation sphere setups, which are not applicable to this RCS example. Then, edit the remaining one to produce the desired bistatic RCS setup.

1. Under *Radiation* in the Project Manager, right-click **3D** and choose **Delete**.
2. Also, right-click **Azimuth** and choose **Delete**.
3. Double-click **Elevation** to edit this radiation sphere setup.

The *Far Field Radiation Sphere Setup* dialog appears.

4. Specify the following settings in the **Infinite Sphere** tab:
 - a. Change the **Name** to **Bistatic**.
 - b. Under **Phi**, set:
 - **Start = 0 deg**
 - **Stop = 0 deg**
 - **Step Size = 0 deg**
 - c. Under **Theta**, set:
 - **Start = 0 deg**
 - **Stop = 180 deg**
 - **Step Size = 1 deg**

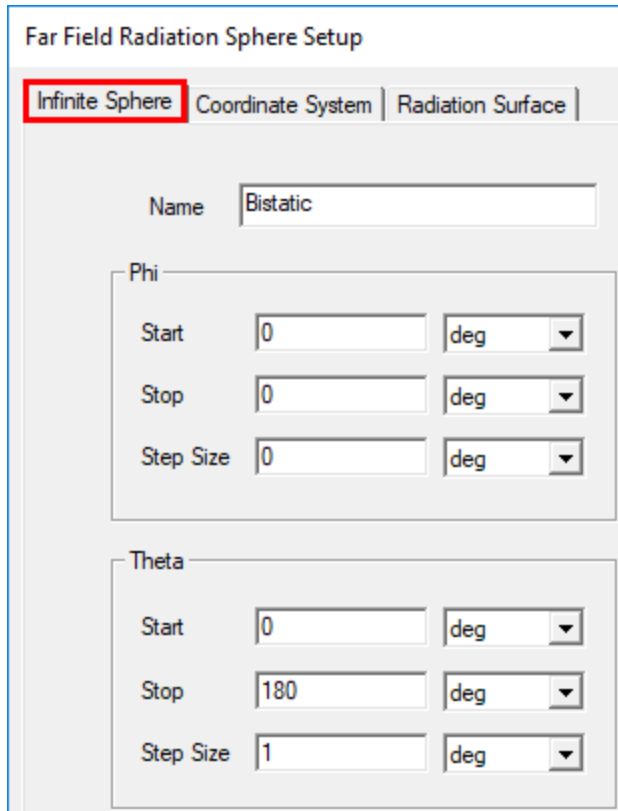

5. Under the **Coordinate System** tab, ensure that the **Use global coordinate system** option is selected to orient the sphere according to the global coordinate system (CS) axes.

Note:

If you needed to orient the sphere according to a user-defined CS, you would select **Use local coordinate system** and then select a previously defined CS from the **Choose from existing coordinate systems** list.

6. Click the **Radiation Surface** tab to review its contents.

For this example, there's nothing that can be changed under this tab. A note explains that you would have to first create a *Face List* before you can define a *Custom Radiation Surface*.

7. Click **OK** to accept the far field radiation sphere setup.

The previous setup is revised, and the *Bistatic* setup now appears under *Radiation* in the Project Manager.



Create Monostatic RCS Plot

First, create a plot for the monostatic RCS setup.

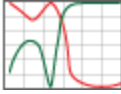
1. From the **Results** ribbon tab, click  **Monostatic RCS Report** >  **2D**.

The *Report* dialog box appears.

2. Specify the following settings under the **Trace** tab:
 - a. Ensure that **IWaveTheta** is selected from the **Primary Sweep** drop-down menu.
 - b. In the **Category** list, verify that **Monostatic RCS** is selected.
 - c. In the **Quantity** list, select **NormMonostaticRCSTotal**.
 - d. In the **Function** list, select **dB**. (You may need to scroll down, or resize the dialog box to see this item.)

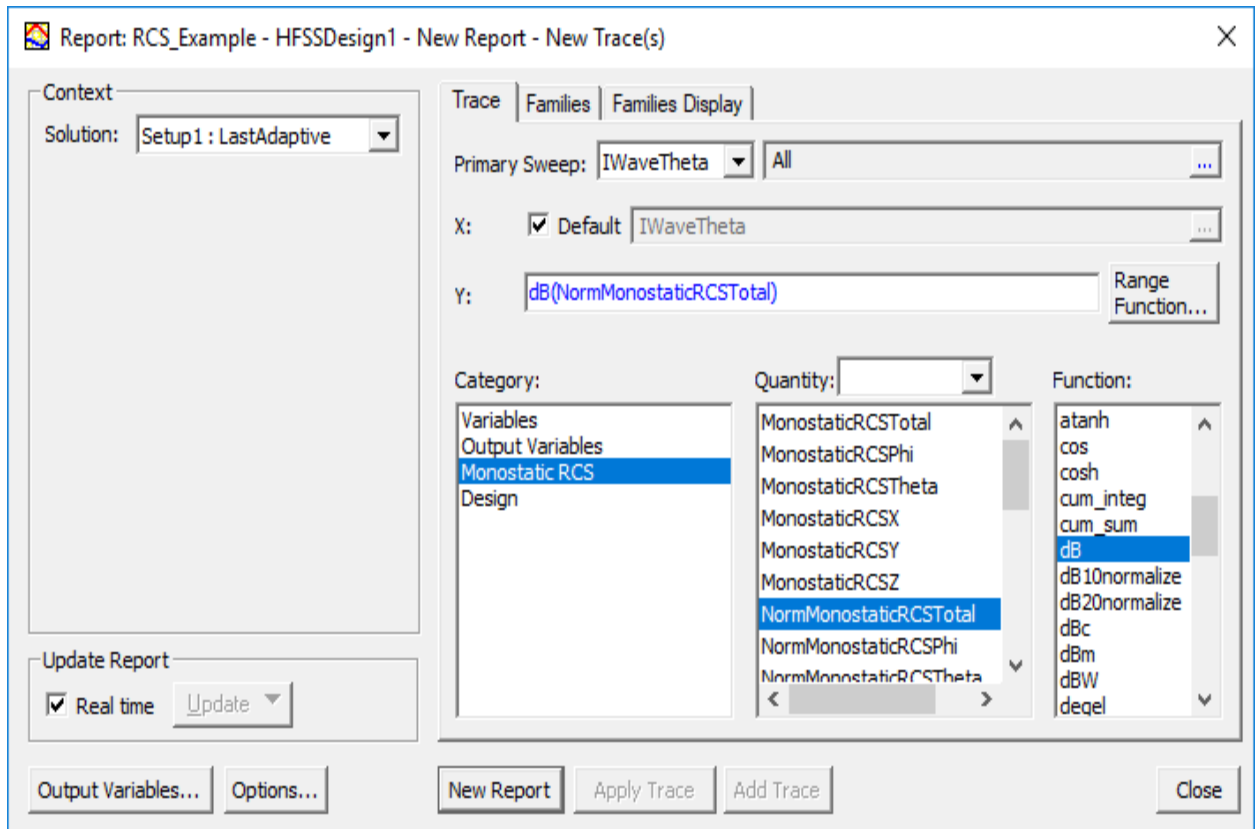

3. Click **New Report** and then **Close**.

A Monostatic RCS Plot appears in a new window and it's listed under *Results* in the Project Manager.

Monostatic RCS Plot 1

HFSSDesign1

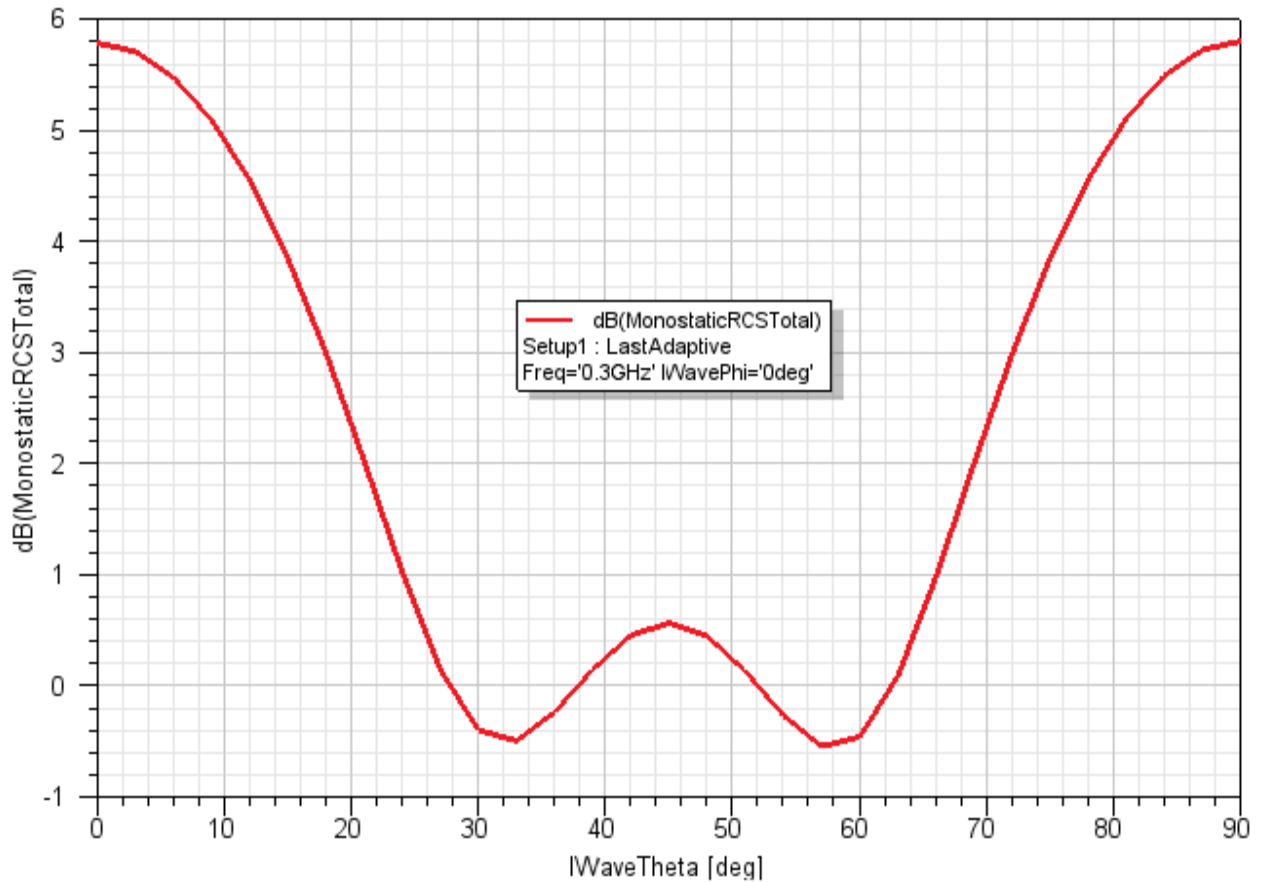
Ansys
2023 R1

Create Bistatic RCS Plot

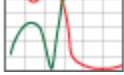
1. On the **Results** ribbon tab, click  **Far Fields Report** >  **2D**.

The *Report* dialog box appears.

Note:

For the *Geometry* settings, *Bistatic* is already specified, and there is no other choice (since this far field setup is the only one available in the design).

2. Specify the following settings under the **Trace** tab:

- a. Ensure that **Theta** is selected from the **Primary Sweep** drop-down menu.
- b. In the **Category** list, verify that **Normalized Bistatic RCS**.
- c. In the **Quantity** list, ensure that **NormRCSTotal** is selected.
- d. In the **Function** list, select **dB**. (You may need to scroll down, or resize the dialog box to see this item.)

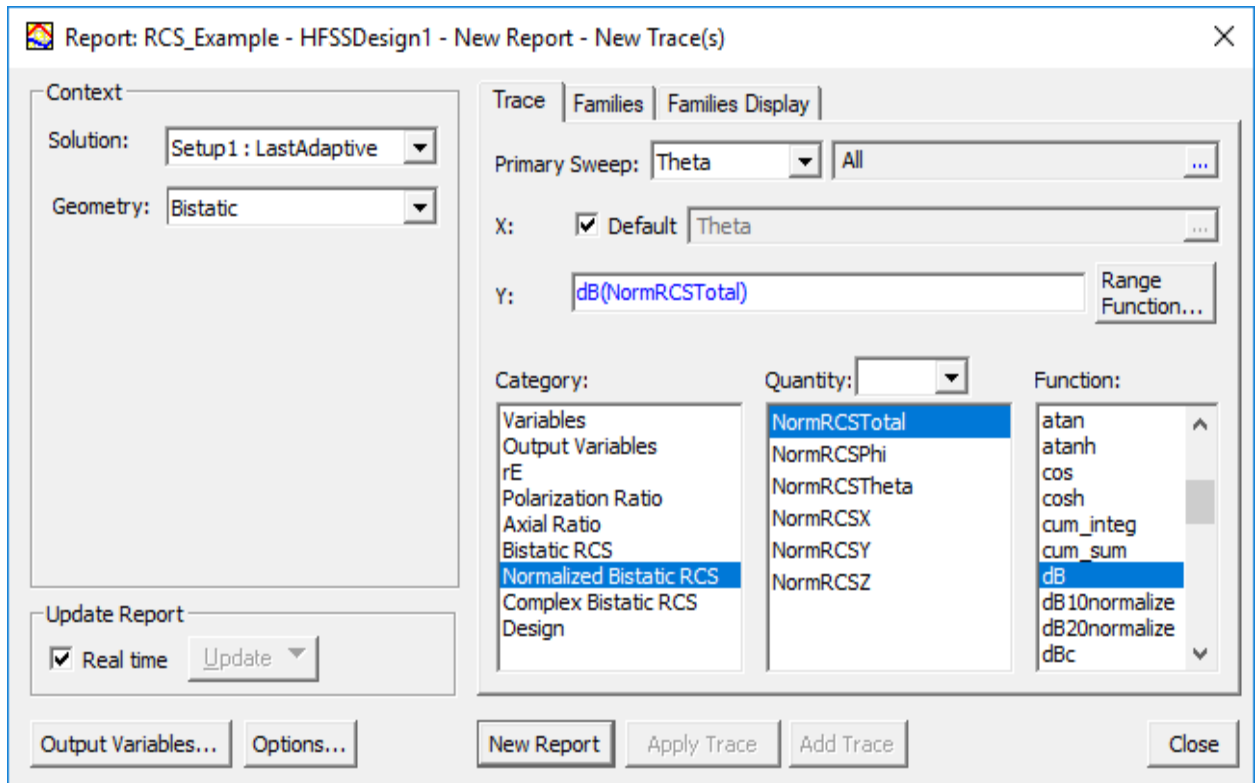

3. On the **Families** tab, verify that the *Value* for **IWaveTheta** is **0deg**, meaning that, of all the incident waves, we are going to plot the bistatic pattern of this one only.

Note:

To change the value, click the elipsis button (...) in the *Edit* column of the same row.

4. Click **New Report** and then **Close**.

A Normalized Bistatic RCS Plot appears in a new window and it's listed under *Results* in the Project Manager.

Normalized Bistatic RCS Plot 1

HFSSDesign1

Ansys
2023 R1

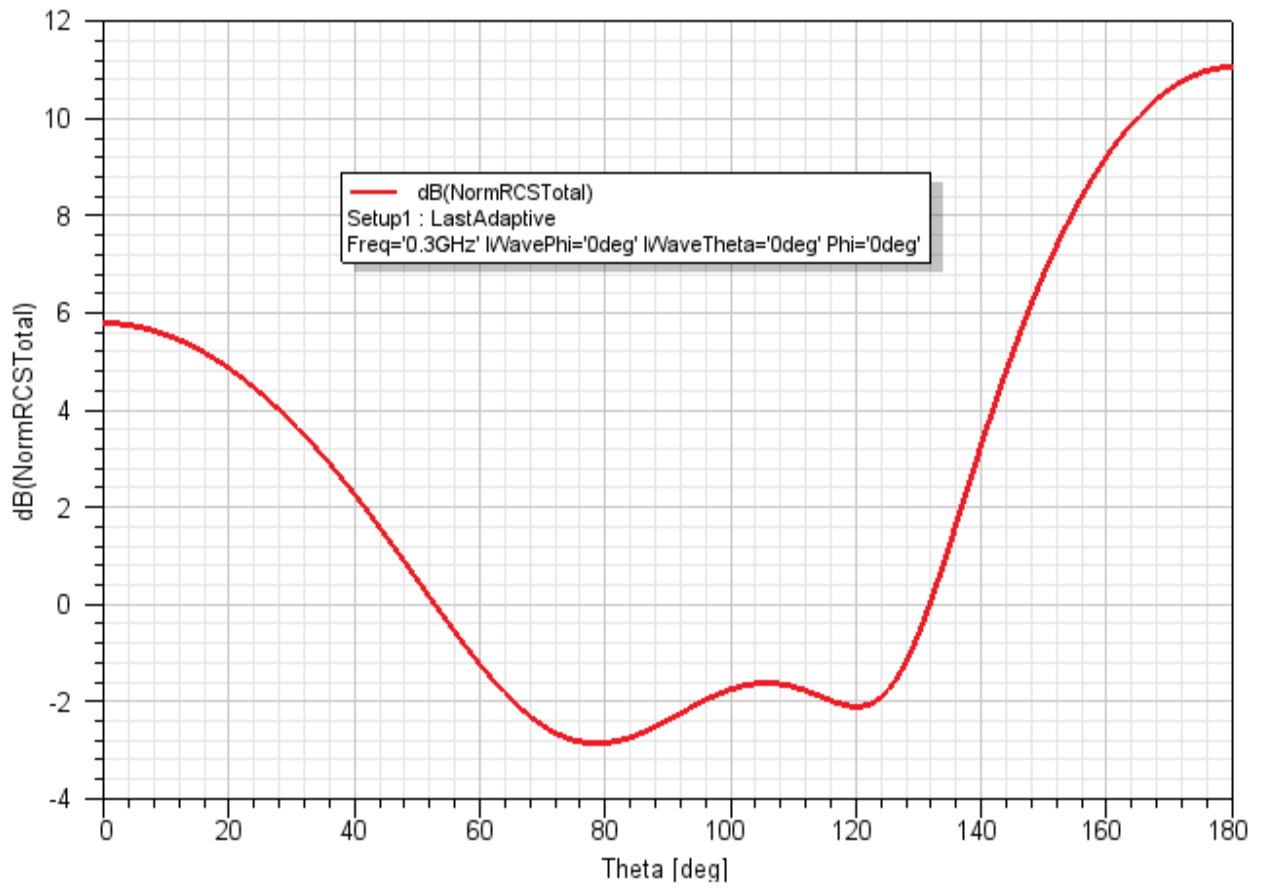

5.  **Save** your project.

5 - Optionally, Restore Current View Orientations

You have completed this getting started guide.

If you prefer to use the new view orientations implemented in version 2024 R1 of the Ansys Electronics Desktop application, clear the *Use Legacy View Orientation* option as follows:

1. From the menu bar, click **View > Options**.

The *3D UI Options* dialog box appears.

2. Ensure that **Enable Legacy View Orientation** is cleared:

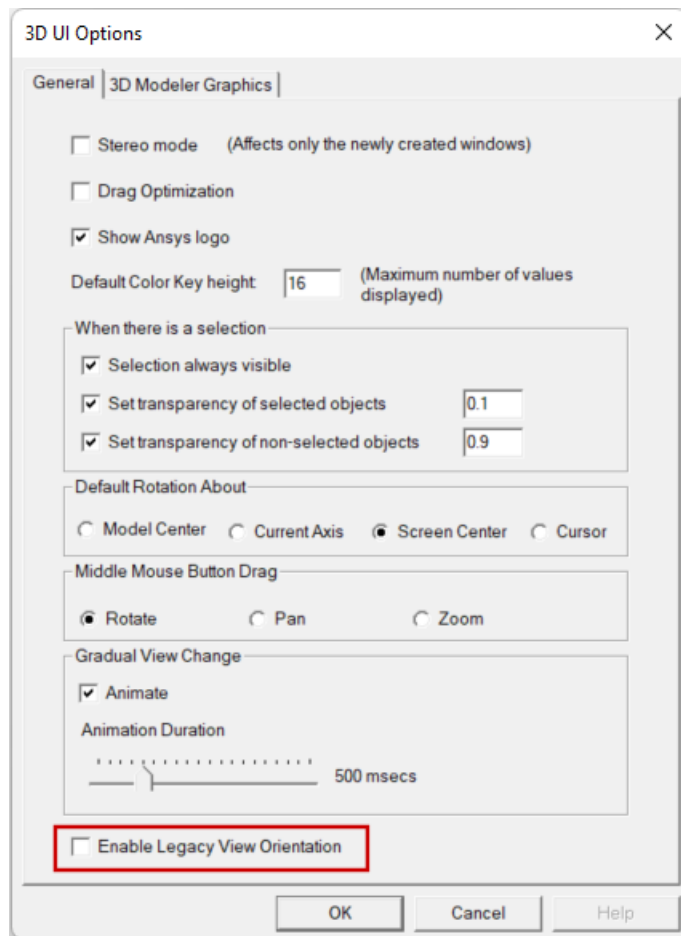

3. Click **OK**.

The settings in the 3D UI Options dialog box are global. Your choice is retained for all future program sessions, projects, and design types that use the 3D Modeler or that produce 3D plots of results.

You can now save and close this project.